

Conexões Aço Inox Sanitárias

Tubos

Ø	A	e	P. máx à 20° C [Kgf/cm²]
1"	25,4	1,2	95,0
1½"	38,1	1,2	50,0
2"	50,8	1,2	30,0
2"	50,8	1,5	50,0
2½"	63,5	1,5	30,0
3"	76,2	1,5	18,0
3"	76,2	2,0	36,0
4"	101,6	2,0	18,0
5"	127,0	2,0	17,0
6"	152,4	2,0	16,0

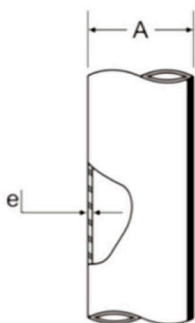

Tê Reto solda/cruzeta solda

Ø	A	B	e
1"	96,0	48,0	1,5
1½"	114,4	57,2	1,5
2"	152,4	76,2	1,5
2½"	154,0	77,0	1,5
3"	166,0	83,0	2,0
4"	197,0	98,5	2,0
5"	211,4	105,7	2,5
6"	226,0	113,0	2,0
8"	241,4	120,7	3,0

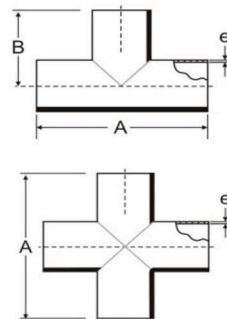

Curva 45° solda

Ø	A	e
1"	14,6	1,5
1½"	21,9	1,5
2"	29,2	1,5
2½"	36,5	1,5
3"	43,7	2,0
4"	58,3	2,0
5"	72,9	2,5
6"	87,5	2,0
8"	116,6	3,0

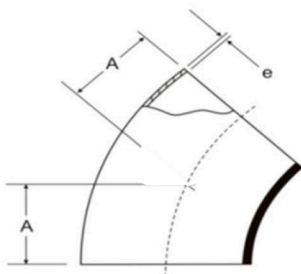

Curva 90° solda

Ø	A	e
1"	38,1	1,5
1½"	57,2	1,5
2"	76,2	1,5
2½"	95,3	1,5
3"	114,3	2,0
4"	152,4	2,0
5"	190,5	2,5
6"	228,6	2,0
8"	304,8	3,0

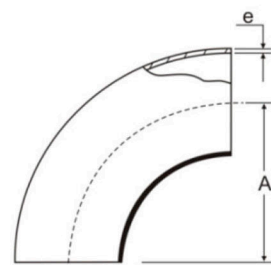

Curva 180° solda

Ø	A	B	e
1"	76,2	50,8	1,5
1½"	114,4	76,2	1,5
2"	152,4	101,6	1,5
2½"	190,5	127,0	1,5
3"	228,6	152,4	2,0
4"	304,8	203,2	2,0
5"	381,0	254,0	2,5
6"	457,2	304,8	2,5

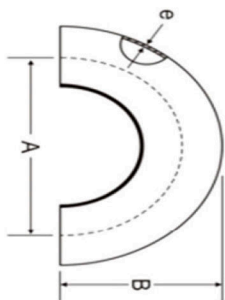

Tê 45° solda

Ø	A	B	C	e
1"	152,4	127,0	25,8	2,0
1½"	187,3	157,1	30,4	2,0
2"	222,2	180,9	41,5	2,0
2½"	254,0	215,7	38,2	2,0
3"	273,0	225,2	47,8	2,0
4"	325,4	272,8	52,0	2,0

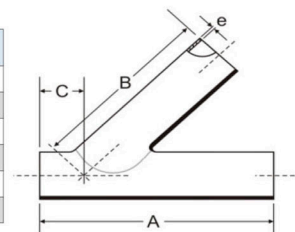

Tê Reto de Redução solda

Ø	A	B	e
1½" x 1"	114,4	57,2	1,5
2" x 1"	152,4	76,2	1,5
2" x 1½"	152,4	76,2	1,5
2½" x 1"	154,0	77,0	1,5
2½" x 1½"	154,0	77,0	1,5
2½" x 2"	154,0	77,0	1,5
3" x 1½"	166,0	83,0	2,0
3" x 2"	166,0	83,0	2,0
3" x 2½"	166,0	83,0	2,0
4" x 2"	197,0	98,5	2,0
4" x 2½"	197,0	98,5	2,0
4" x 3"	197,0	95,5	2,0
6" x 4"	226,0	113,0	2,0

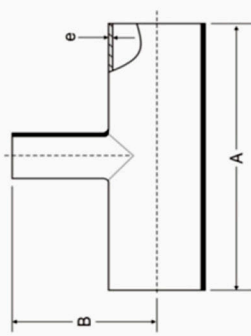

Redução Solda

Ø	e
1½" x 1"	2,0
2" x 1"	2,0
2" x 1½"	2,0
2½" x 1"	2,0
2½" x 1½"	2,0
2½" x 2"	2,0
3" x 1½"	2,0
3" x 2"	2,0
3" x 2½"	2,0
4" x 2"	2,0
4" x 2½"	2,0
4" x 3"	2,0
5" x 4"	2,0
6" x 4"	2,0
6" x 5"	2,0
8" x 6"	2,5

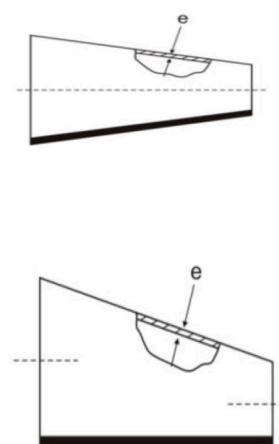

*A empresa reserva-se o direito de efetuar alterações sem aviso prévio.

*As medidas podem sofrer variações dependendo do lote do material.

União TC

Ø	A		
	curta	longa	exp
½"	27,2	-	-
¾"	27,2	-	-
1"	27,2	59,0	39,8
1½"	27,2	59,0	45,8
2"	27,2	59,0	52,6
2½"	27,2	59,0	59,0
3"	27,2	59,0	61,8
4"	33,6	59,0	-
6"	33,6	59,0	-
8"	33,6	59,0	-

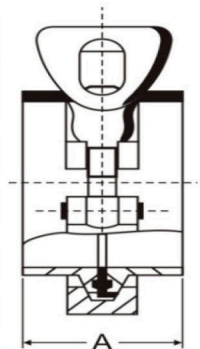

Niple solda TC / Niple longo TC

Ø	A	A	B	exp
	curto	longo		
½"	12,7	-	25,0	-
¾"	12,7	-	32,0	-
1"	12,7	21,5	50,0	-
1½"	12,7	21,5	50,0	19,0
2"	12,7	21,5	64,0	22,0
2½"	12,7	21,5	77,0	25,4
3"	12,7	21,5	91,0	28,6
4"	15,9	28,6	119,0	30,0
5"	15,9	28,6	144,5	-
6"	15,9	28,6	167,0	-
8"	15,9	28,6	220,6	-

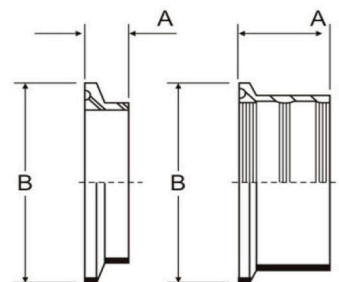

Abraçadeira TC

Ø	A		Pressão de serviço [Kfg/cm²]	
	normal	alta pressão	normal	alta pressão
½" e ¾"	37,0	-	40,0	-
1" e 1½"	54,0	52,0	34,0	70,0
2"	67,0	66,0	28,0	70,0
2½"	81,0	79,0	26,0	70,0
3"	94,0	92,0	22,0	70,0
4"	122,0	120,0	12,0	70,0
6"	172,0	168,0	8,0	20,0

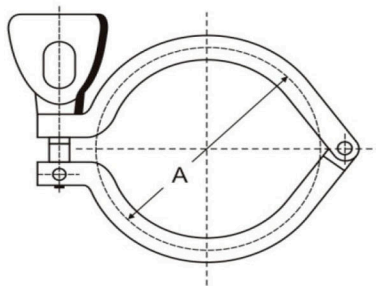

As pressões acima referem-se à t=20°C.
Para t=120° reduzi-las em 40%

Anel de vedação TC

Ø	A	e
½"	34,0	1,8
¾"	34,0	1,8
1"	52,0	1,8
1½"	52,0	1,8
2"	66,0	1,8
2½"	79,0	1,8
3"	93,0	1,8
4"	121,0	1,8
6"	169,0	1,8
8"	223,0	1,8

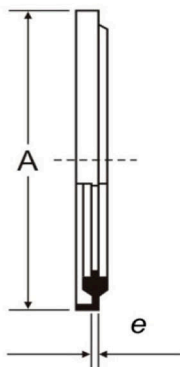

Tampão TC

Ø	A	e
1"	50,0	6,3
1½"	50,0	6,3
2"	64,0	6,3
2½"	77,0	6,3
3"	91,0	6,3
4"	119,0	7,9
6"	167,0	7,9

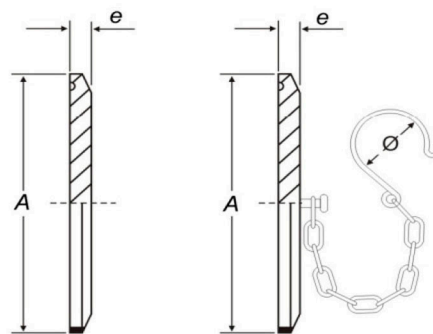

Niple adaptador TC x mangueira

Ø	A
1"	72,7
1½"	92,7
2"	92,7
2½"	112,7
3"	112,7
4"	115,9
6"	135,9

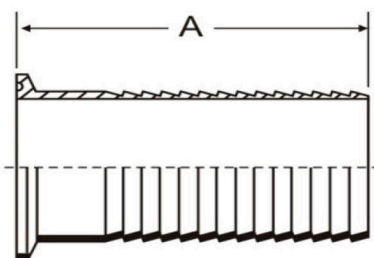

Curva 90° 2TC

Ø	A
1"	50,8
1½"	69,9
2"	88,9
2½"	108,0
3"	127,0
4"	168,3
6"	244,5

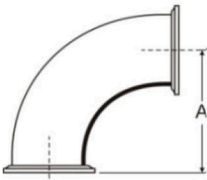

Tê reto 3TC

Ø	A	B
1"	121,4	60,7
1½"	139,8	69,9
2"	177,8	88,9
2½"	179,4	89,7
3"	191,4	95,7
4"	228,8	114,4
6"	257,8	128,9

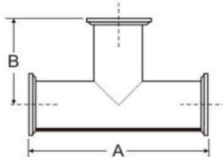

Curva 180° 2TC

Ø	A	B
1"	76,2	63,5
1½"	114,4	88,9
2"	152,4	114,3
2½"	190,5	139,7
3"	228,6	165,1
4"	304,8	219,1
6"	457,2	320,7

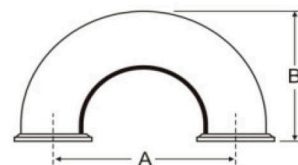

Curva 45° 2TC

Ø	A
1"	27,3
1½"	34,6
2"	41,9
2½"	49,2
3"	56,4
4"	74,2
6"	103,4

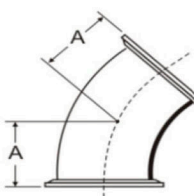

Cruzeta 4TC

Ø	A
1"	121,4
1½"	139,8
2"	177,8
2½"	179,4
3"	191,4
4"	228,8

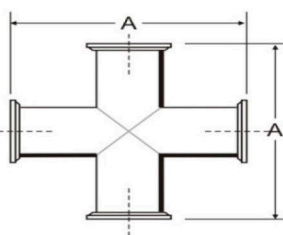

Tê 45° 3TC

Ø	A	B	C
1"	177,8	139,7	38,5
1½"	212,7	169,8	43,1
2"	247,6	193,6	54,2
2½"	279,4	228,4	50,9
3"	298,4	237,9	60,5
4"	357,2	288,7	67,9

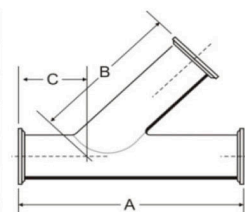

Curva de redução 90° 2TC

Ø	A	B
1½" x 1"	50,8	50,8
2" x 1"	50,8	50,8
2" x 1½"	69,9	69,9
2½" x 1"	50,8	50,8
2½" x 1½"	69,9	69,9
2½" x 2"	88,9	88,9
3" x 1½"	69,9	69,9
3" x 2"	88,9	88,9
3" x 2½"	108,0	108,0
4" x 2"	88,9	92,1
4" x 2½"	108,0	111,2
4" x 3"	127,0	130,2
6" x 4"	168,3	168,3

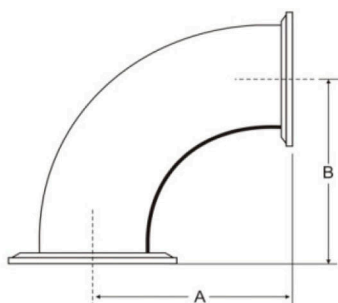

Tê redução 3TC

Ø	A	B
1½" x 1"	139,8	69,9
2" x 1"	177,8	88,9
2" x 1½"	177,8	88,9
2½" x 1"	179,4	89,7
2½" x 1½"	179,4	89,7
2½" x 2"	179,4	89,7
3" x 1½"	191,4	95,7
3" x 2"	191,4	95,7
3" x 1½"	191,4	95,7
4" x 2"	228,8	111,2
4" x 2½"	228,8	111,2
4" x 3"	228,8	112,2
6" x 4"	257,8	128,9

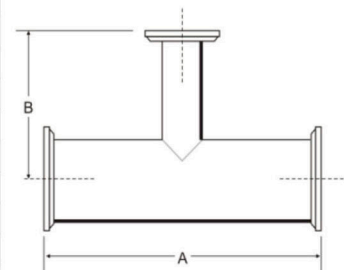

Redução 2TC (Concêntrica ou Excêntrica)

Ø
1½" x 1"
2" x 1"
2" x 1½"
2½" x 1"
2½" x 1½"
2½" x 2"
3" x 1½"
3" x 2"
3" x 1½"
4" x 2"
4" x 2½"
4" x 3"
6" x 4"

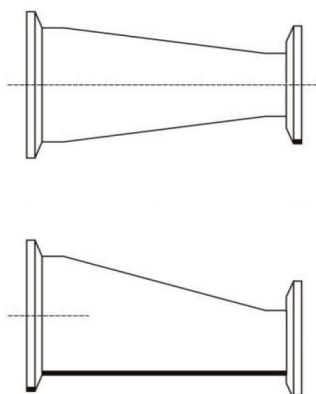

*A empresa reserva-se o direito de efetuar alterações sem aviso prévio.
*As medidas podem sofrer variações dependendo do lote do material.

União RJT

Ø	A	
	solda	exp.
1"	35,9	41,2
1½"	35,9	49,2
2"	35,9	53,2
2½"	35,9	65,2
3"	35,9	65,2
4"	35,9	-
5"	47,8	-
6"	47,8	-

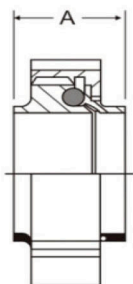

União DIN

Ø	A
½"	34,0
¾"	34,0
1"	38,0
1½"	38,0
2"	39,0
2½"	40,0
3"	48,8
4"	49,5
5"	62,0
6"	69,5

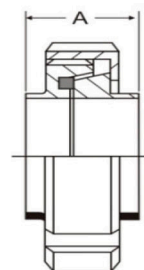

União SMS

Ø	A	
	solda	exp
1½"	34,9	38,9
2"	34,9	44,9
2½"	34,9	46,9
1"	38,9	46,9
3"	38,9	66,9
4"	53,9	-

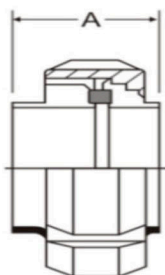

Porca Circular

Ø	RJT		SMS		DIN	
	A	B	A	B	A	B
½"	-	-	-	-	18,0	38,0
¾"	-	-	-	-	18,0	44,0
1"	22,0	59,0	20,0	51,0	21,0	63,0
1½"	22,0	72,0	25,0	74,0	21,0	78,0
2"	22,0	86,0	26,0	84,0	22,0	92,0
2½"	22,0	98,0	30,0	100,0	25,0	112,0
3"	22,0	111,0	32,0	114,0	29,0	127,0
4"	22,0	136,0	45,0	154,0	31,0	148,0
5"	26,0	187,0	-	-	35,0	178,0
6"	26,0	225,0	-	-	40,0	210,0

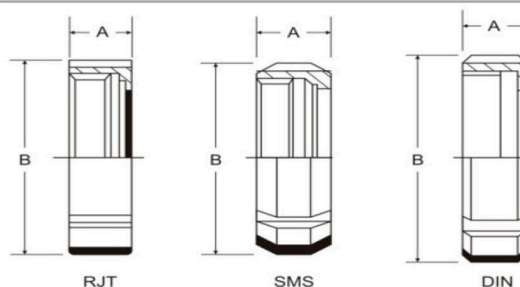

Fornecemos também Porca Tampão e Porca Tampão com corrente.

Tampão

Ø	RJT		SMS		DIN	
	A	B	A	B	A	B
1"	10,0	42,0	7,5	35,5	10,0	44,0
1½"	10,0	54,0	8,0	55,0	10,0	56,0
2"	10,0	67,0	9,0	65,0	11,0	68,0
2½"	10,0	79,7	9,0	80,0	12,0	86,0
3"	10,0	92,6	11,0	93,0	12,0	100,0
4"	10,0	117,3	13,0	127,0	15,0	121,0
5"	10,0	143,0	-	-	17,0	156,0
6"	10,0	168,0	-	-	19,0	176,0

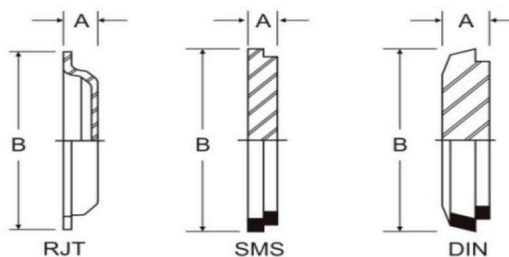

Fornecemos também tampão com corrente.

Anéis de Vedação

Ø	RJT		SMS		DIN	
	e	A	e	A	e	A
1"	6,6	33,2	5,5	32,0	5,0	40,0
1½"	6,6	45,9	5,5	48,0	5,0	52,0
2"	6,6	58,6	5,5	61,0	5,0	64,0
2½"	6,6	71,3	5,5	73,5	5,0	81,0
3"	6,6	84,0	5,5	86,0	5,0	95,0
4"	6,6	109,7	5,5	103,5	6,0	114,0
5"	6,6	142,0	-	-	7,0	142,0
6"	6,6	158,0	-	-	7,0	167,0

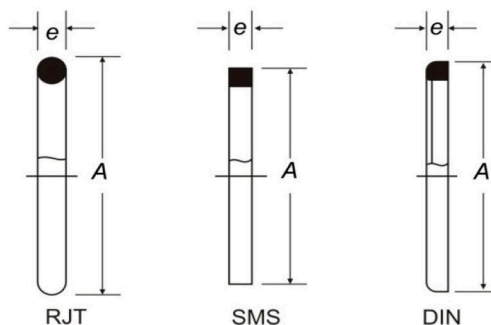

*A empresa reserva-se o direito de efetuar alterações sem aviso prévio.

*As medidas podem sofrer variações dependendo do lote do material.

Macho Solda

Ø	RJT		SMS		DIN	
	A	B	A	B	A	B
1/2"	-	-	-	-	21,0	28,0
3/4"	-	-	-	-	21,0	34,0
1"	26,5	49,4	16,0	39,8	24,0	52,0
1 1/2"	26,5	58,1	20,0	59,8	24,0	65,0
2"	26,5	72,4	20,0	69,8	24,0	78,0
2 1/2"	26,5	85,1	24,0	84,8	27,0	95,0
3"	26,5	97,8	24,0	97,8	31,0	110,0
4"	26,5	123,2	35,0	131,2	31,0	130,0
5"	26,5	150,0	-	-	46,0	170,0
6"	26,5	175,0	-	-	50,0	190,0

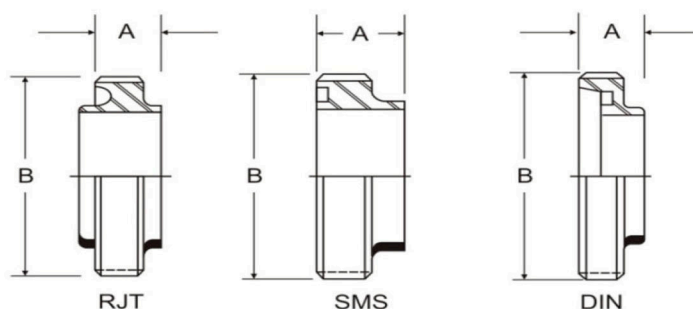

Macho Expansão

Ø	RJT		SMS	
	A	B	A	B
1"	20,0	45,4	20,0	39,8
1 1/2"	24,0	58,1	23,0	59,8
2"	28,0	72,4	25,0	69,8
2 1/2"	32,0	85,1	30,0	84,8
3"	32,0	97,8	35,0	97,8

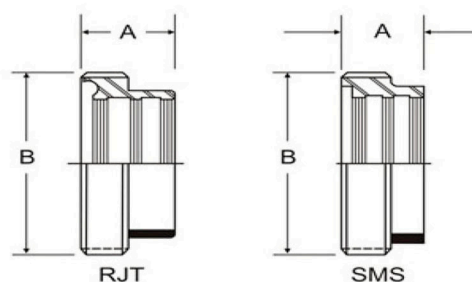

Niple Solda

Ø	RJT		SMS		DIN	
	A	B	A	B	A	B
1/2"	-	-	-	-	17,0	22,5
3/4"	-	-	-	-	17,0	28,5
1"	13,0	42,0	13,0	35,3	20,0	44,0
1 1/2"	13,0	53,9	13,0	55,0	20,0	56,0
2"	13,0	67,6	13,0	65,0	21,0	68,5
2 1/2"	13,0	80,3	13,0	80,0	24,0	86,0
3"	13,0	93,0	13,0	93,0	24,0	121,0
4"	15,0	117,7	17,0	127,0	28,0	121,0
5"	20,0	145,0	-	-	28,0	150,0
6"	20,0	168,0	-	-	37,0	176,0

